



AC 41

Active Antenna Combiner

Quick Guide	Kort vejledning
Kurzanleitung	Pikaohje
Guide rapide	Γρήγορος οδηγός
Guida rapida	Kısa Kılavuz
Guía de inicio rápido	Краткая инструкция
Guia rápido	快速指南
Beknopte handleiding	快速使用指南
Krótką instrukcja obsługi	クイックガイド
Snabbguide	퀵 가이드

SENNHEISER

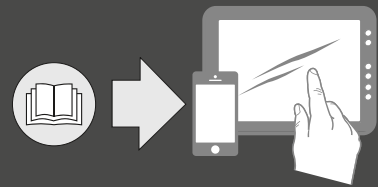

Sennheiser Documentation App



or online at
www.sennheiser.com/download

AC 41_

Sennheiser electronic GmbH & Co. KG

Am Labor 1, 30900 Wedemark, Germany
www.sennheiser.com

Publ. 03/18, 578662/A02

AC 41

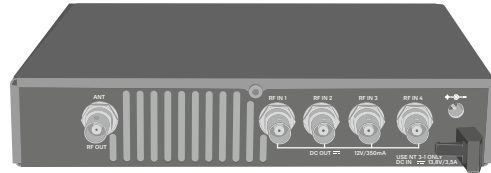

Setup

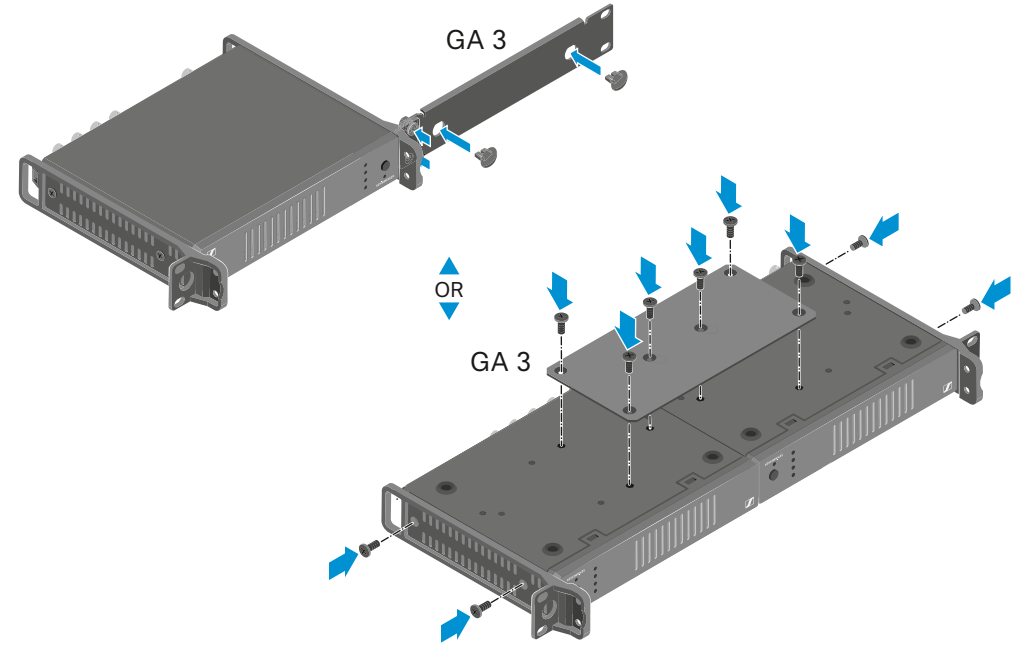

Operating elements

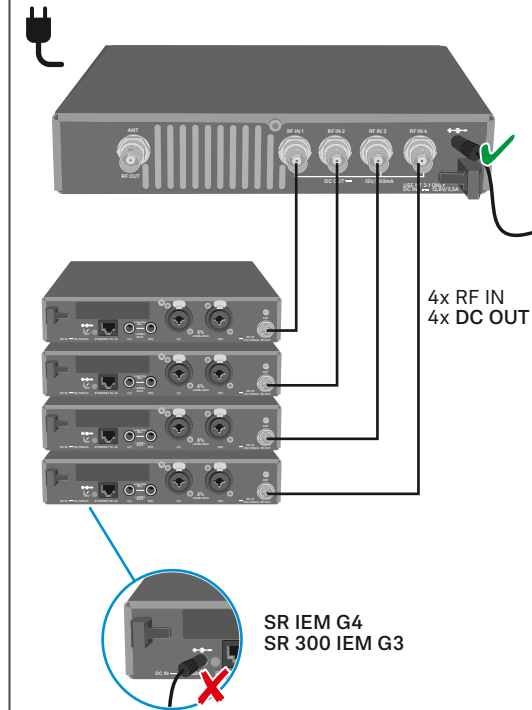
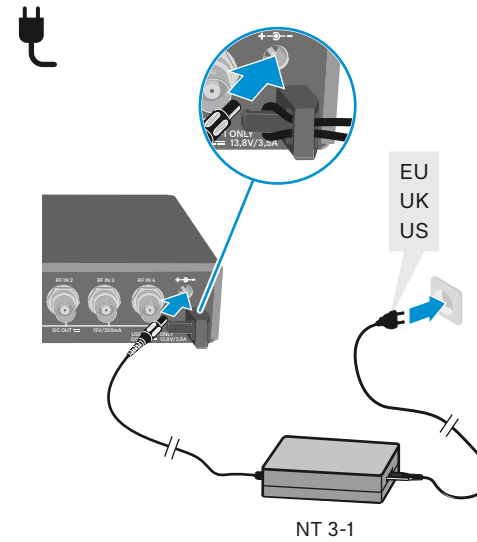
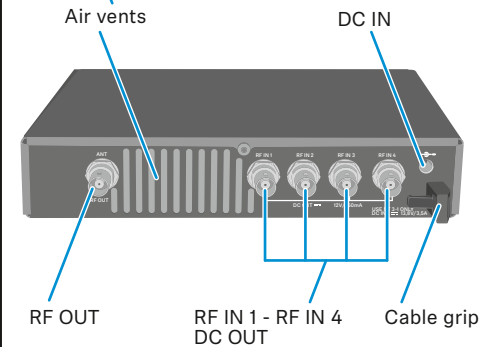
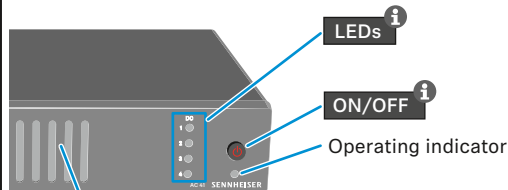

ON/OFF

ON/Standby

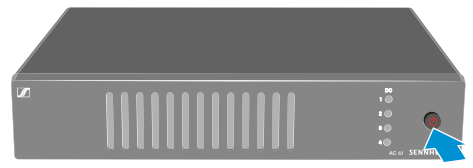

	AC 41	transmitter	LEDs
short	on	RF signal	on LEDs
long	standby	off	off

OFF

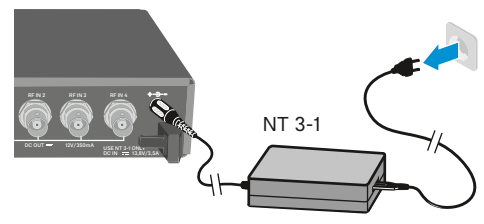

LEDs

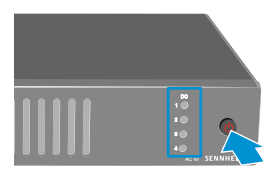

AC 41 = on

LEDs	DC to transmitters
on	
off	

Connecting devices

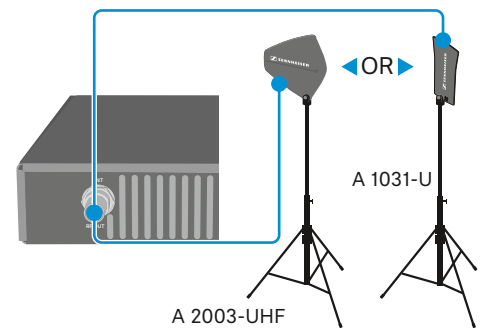

Remote antennas and maximum cable lengths

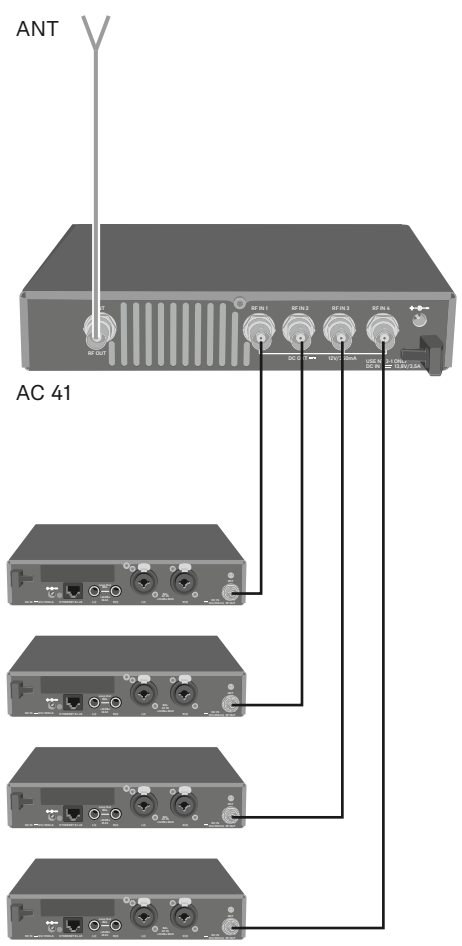

SR IEM G4
SR 300 IEM G3

Block diagram

